

Position	Amount	Type number	Description	PG
1	1	1382693309	EXTENSION PLATE BL 2,00X572X832 TKHS315M	40
2	41	6209110995	Flange nut	10
3	23	141151340	Washer	10
4	4	1395200611	BEARING BOLT	14
5	2	1382678121	SUPPORT BL 1,00X70X764,5 TVL	26
6	2	6132685086	HEX.SOCKET COUNTERS.HEAD SCREW M 6X10 VE	10
7	25	6209114230	Flange nut	10
8	2	1381693917	PLUG RD20/15-17X11,5	11
9	2	1382693828	BRACKET, PRESSURE ROLLER BD 2,99X64X213	21
10	1	1485693889	CROSSCUT FENCE GUIDE ROD RD 20X2X820 TKH	27
11	26	6103001178	Hex head screw	10
12	2	1382693856	ANGLE BRACKET BL 2,50X30X116	23
13	2	141123420	Self-tapp. counters. screw	10
14	1	2391091725	End piece	12
15	1	1391200145	PLUG QUERANSCHLAG	14
16	1	1393005315	FENCE EXTRUSION 300 MM	25
17	2	6110076574	Truss head screw	10
18	21	141151940	Washer	10
19	4	6241125058	Knurled nut	12
20	1	7001144191	STARKNOB SCREW M 8X23 (DIN 933) VERZINKT	13
21	1	1390018033	STOP RULE	25
22	4	6172032905	CROSS REC'D PAN HEAD TAP.SCREW ST 3,5X16	10
23	1	6174155800	Self-tapp. counters. screw	10
24	1	1382409775	STOP RULE, LOWER BL 2,99 (N.ZCHNG)	27
25	1	1381410559	GLIDE PIECE	12
26	1	6264139374	CAGE NUT M 8 BLECHSTÄRKE 1,8-3,2	12
27	6	141130100	Hexagonal nut	10
28	12	6103015675	Hex head screw	10
29	2	1381409879	GUIDE PIECE QUERANSCHLAG	14
30	1	1010017811	FENCE EXTRUSION 300 MM	27
32	6	6130019585	SLOTTED FLAT HEAD SCREW M 6X20 VERZ.	10
33	1	1382693287	TABLE PANEL BL 2,00X668X868 TKHS315M	39
34	1	1010186710	MITRE FENCE ASSEMBLY ET	42
35	1	1482693691	CHIP CASE GUIDE PANEL BL 2,00X163X440 HI	30
36	1	1482693179	BRACKET FL 25X10X65 TKHS315M	25
37	7	6202002291	HEXAGON NUT, PREV. TORQUE TYPE	10
38	7	141114860	Hexagon head screw	12
39	1	1381406667	REMOVABLE TABLE SECTION	24
40	1	1382721906	HOSE CARRIER TKHS 315 D&D ET	14
41	2	1482408962	CAM PLATE BL 2,99XRD25/RDI 6,5	10
42	1	1382721892	GUARD PLATE TKHS 315 D&D ET	18

43	1	6172028215	Fillister head screw	10
44	1	141150110	Washer	10
45	1	1142694260	SCALE 0,30X13X413 0,00-38,80 CM	18
46	1	7854158010	CORRUGATED HOSE RDI 36,2X1500 PROFIL D	27
47	1	1010738535	SAW BLADE GUARD W/SUCTION PORT TKHS315M	24
48	1	1142694464	ARBOR TILT SCALE 0,25X13 47-0 GRAD	16
49	1	1482693683	CHIP CASE GUIDE PANEL BL 2,00X163X440 VO	30
50	7	6202002305	HEXAGON NUT, PREV. TORQUE TYPE	10
51	2	1485412910	Spacer sleeve	12
52	2	6110000659	Truss head screw	10
53	1	1383694279	FENCE GUIDE EXTRUSION 463 MM TKHS315M	28
54	3	6110031325	Truss head screw	10
55	1	1485693161	SPACER SLEEVE RDI 12X7	12
56	1	1383680260	Angle,KGT 501	30
57	1	1383158458	RIP FENCE EXTRUSION 570 MM	31
58	1	1382680053	Locking element	33
59	2	6132087995	Countersunk screw	10
60	1	7016050711	STARLOCK	10
61	1	1392205620	Clamping plate,BL 1X26X91,5	12
62	1	6632111175	BOLT WITH HEAD	13
63	1	2390205484	Cam lock lever	19
64	1	1010680243	Parallel guide,KGT501/TKHS	44
70	1	1010692586	WHEEL SET TKHS315M GUMMIBEREIFT	29
71	4	1382693597	LEG BL 1,5X142X842 TKHS315M	29
72	2	1382407080	STANCHION BL 1,5X118X844 LANG	23
73	2	1382693813	STANCHION BL 1,5X118X644 KURZ / TKHS315M	23
74	1	1394201630	Push stick	19
75	1	1392038481	OPEN END SPANNER BL 3X43/15X145 SW 19X14	15
76	1	1388680470	SLIDING HANDLE RED	31
77	1	1492102829	Key	20
78	1	1010689330	HANDLE BAR (PAIR) TKHS315C/M	20
79	2	6123612815	RAISED CHEESE HEAD SCREW	10
80	2	141150120	Washer	10
81	4	6172001830	Fillister head screw	10
82	1	1381689227	DUST EXTRACTION PORT TKHS315C/M	19
83	1	1382694160	COVER BL 1,50X116X613,5 TKHS315M	27
84	2	141113840	Cap screw	12
85	1	1382694119	CHIPCASE BL 2,00X350X600 TKHS315M	42
86	1	6127059207	Cap screw	10
88	1	1382213749	PRESSURE PLATE BL 2,99X80X60	12
89	1	6209002432	FLANGE NUT	13
90	1	1382407110	SLIDE PLATE BL 1,5X48X137,5	12

94	1	1380693255	RIVING KNIFE CARRIER VORNE TKHS315M	22
95	1	1142694472	SCALE 0,25X20X114 0-85 MM	15
96	2	1380729756	SWIVEL SEGMENT TKHS-M	16
97	4	6103001135	Hex head screw	10
98	8	6305002486	Washer	10
100	1	141110320	Hexagon head screw	12
101	1	6110019007	CUP SQUARE NECK SCREW M 12X50 VERZ.	12
102	1	1010738551	SPLITTING BLADE TKHS315M	27
103	3	1482721857	ANGLE BRACKET TKHS 315 D&D ET	20
104	2	1482721849	ANGLE BRACKET TKHS 315 D&D ET	20
105	1	1382721868	POINTER, BLADE TILT TKHS 315 D&D E	16
106	1	6123022619	RAISED CHEESE HEAD SCREW	10
107	1	2391203523	POINTER RAL 3000-3003	10
108	1	141130930	Hexagonal lock nut	10
109	1	1382721884	MOTOR PLATE TKHS 315 D&D ET	24
110	1	7053081619	CUP SPRING	10
111	1	6110000608	CUP SQUARE NECK SCREW	10
112	4	6132661454	HEX.SOCKET COUNTERS.HEAD SCREW	10
113	1	1383694139	TOOTHED RACK 624 MM TKHS315M	31
114	1	1391200390	Selector wheel	18
115	1	6300016713	Washer	10
116	1	6205032396	HEXAGON THIN NUT	10
117	1	1382722031	CHIP CASE TKHS315 D&D	37
118	1	1010689240	BLADE COLLAR ASSEMBLY ET	26
120	1	1482681987	ANGLE POINTER BL 1,50X10X21,5 KGS303	12
121	8	141150130	Washer	10
122	1	7005155791	WING NUT M 6	13
123	1	6103722010	HEXAGON HEAD SCREW M 12-10 207LANG VER	17
127	1	1010726510	TERMINAL BOX ASSEMBLY TKHS 315M	23
128	1	6442722020	SPACER BUSHING TKHS315 D&D	12
129	1	6721041830	FEATHER KE A 6X4X50	10
131	1	1382694038	HEIGHT-ADJUSTMENT BL 2,99 TKHS315M	29
133	1	7100010180	DEEP GROOVE BALL BEARING	18
136	1	1388721916	BEARING SEA TKHS 315 D&D ET	14
137	1	6260721923	TENSION NU TKHS 315 D&D ET	13
138	1	1382411257	HANDWHEEL BL 2X RD 165	20
139	2	6305002508	WASHER B 13 VERZ.	10
140	1	6201002158	CAP NUT M 12 VERZ.	12
141	1	6121112564	HEXAGON SOCKET HEAD CAP SCREW	10
142	1	7004017433	TURNING TANG	14
144	1	1010722000	FAN WING+FAN COVER TKHS 315 D&D ET	20
145	2	6103001356	HEXAGON HEAD SCREW M 6X16 VERZ.FLECKBESC	10

146	1	1382407063	SWITCH PLATE BD 2,00X85X125,5	13
147	1	8132721980	SWITCH SSK 3,4/4,2 DNB TKHS 315 D&D	33
148	1	1381083779	CAP MOTORWELLE	10
150	1	1010721942	MOTOR, CIRCULAR SAW BENCH T 3,40 DNB 40	62
155	1	1010702140	HANDWHEEL KPL. TKHS315M	24

toolspareparts.com.au

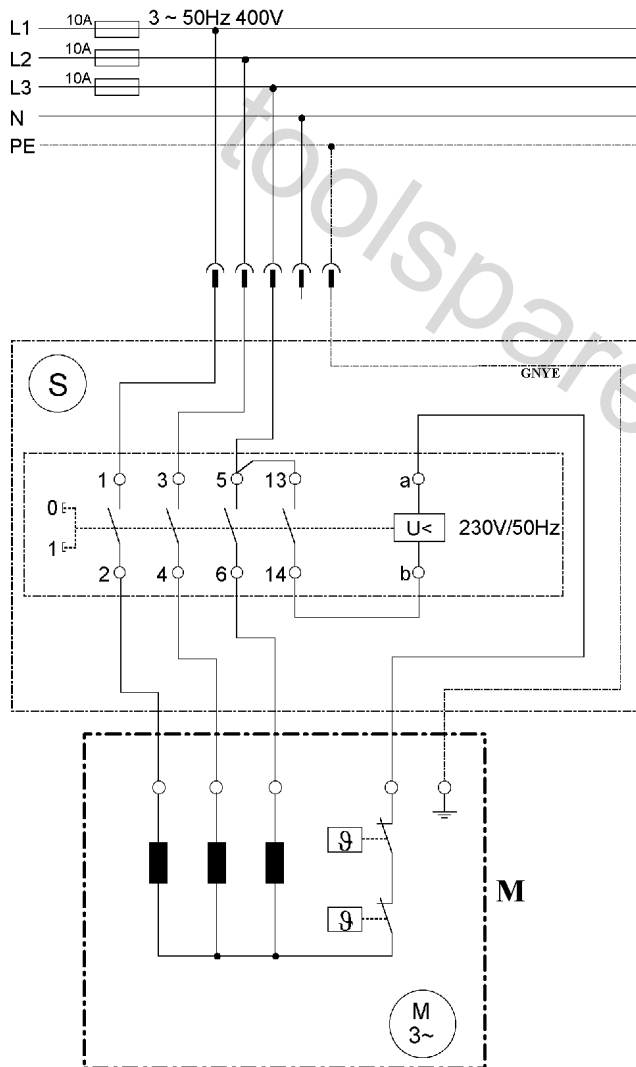

	Litzenfarben	Colour of strands	Couleur des cordons
BK	schwarz	black	noir
WH	weiß	white	blanc
BU	blau	blue	bleu
YE	gelb	yellow	jaune
RD	rot	red	rouge
TR	transparent	transparent	transparent
BN	braun	brown	brun
GY	grau	grey	gris
GNYE	grün-gelb	green-yellow	vert-jaune
BKWH	schwarz-weiß	black-white	noir-blanc
GN	grün	green	vert
OG	orange	orange	orange
VT	violett	violet	violet
TQ	türkis	turquoise	turquoise

	Bedeutung der Kurzzeichen	Meaning of the symbols	Interprétation des symboles
B	Stecker	plug	fiche
C	Kondensator	condenser	condensateur
D	Funkentstördrossel	interference suppression inductance	inductance d'antiparasitage
E	Elektronik-Baustein	electronic unit	unité électronique
I	Induktionsspule	induction coil	bobine d'inductance
K	Klemme	terminal	borne
L	Licht	light	lumière
M	Motor	motor	moteur
O	Überlastschutz	overload cut-out	déclencheur de surintensité
R	Drehrichtungsumschalter	reversing switch	commutateur droite-gauche
S	Schalter	switch	interrupteur
U	Umschalter	change-over switch	commutateur
X	Elektronik-Element	electronic element	élément électronique